

Ontario Western Canada



# WINDOWS & DOORS



# Brighten Your Home Through Innovation

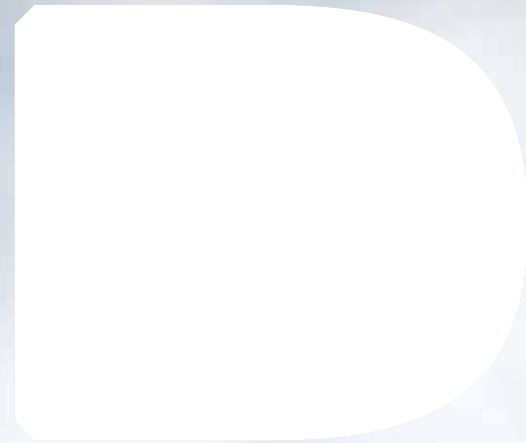

## CONTENTS

Our goals are to not only bring you the next generation of products but to help you enhance your windows as a beautiful expression of your personality.

Procanna is dedicated to offering the highest level of product based on hard work and a commitment to our industry, our customers, our community and the environment. We focus on providing building products that are energy efficient, eco friendly and that require little or no maintenance.

Simply, Procanna is dedicated to providing the highest value products while we continue our efforts to improve energy efficiency and eliminate waste.

Procanna. Working for you today, tomorrow and in the future.

- 4** Premium & Pro Overview
- 6** Premium Window Collection
- 9** Shutter Collection
- 10** Pro Window Collection
- 14** Entrance Collection
- 18** Patio Door Collection
- 20** Hardware
- 21** Decorative Options
- 22** Product Performance Ratings
- 23** Features and benefits
- 24** Procanna Warranties



PREMIUM CASEMENT CONSTRUCTION

1. 3-1/4" frame profile
2. Triple glazed standard 1-3/8" overall glass thickness
3. Two 1/2" air chambers that come standard with LoE and Argon gas
4. S Class Super Spacer
5. Precision mitred fusion welded sash and frame
6. New multipoint lock design with 180 degrees of operation

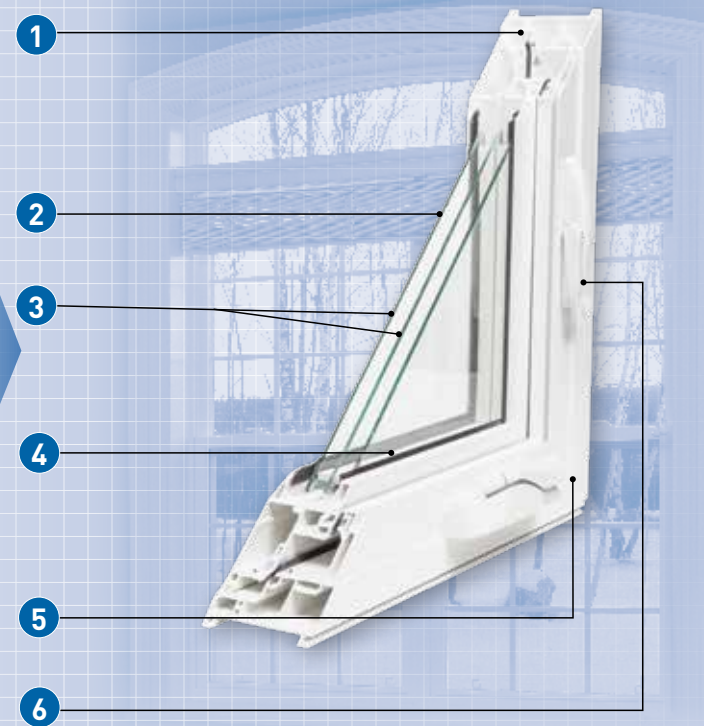

PRO CASEMENT CONSTRUCTION

1. 3-1/4" frame profile
2. Double pane standard 7/8" overall glass thickness, optional triple pane also 7/8" overall glass thickness
3. Available with LoE and Argon gas
4. S Class Super Spacer
5. Precision mitred fusion welded frame and sash

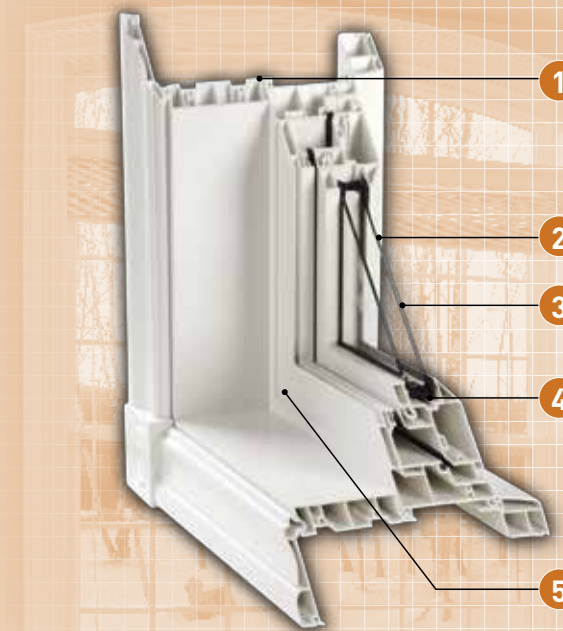

The Pro Collection offers all of the same features and benefits as the Premium collection, but its performance is limited by an overall glass thickness of 7/8". Double and triple glazing is available for this series, but always respecting the 7/8" limitation.

PREMIUM FEATURES AND BENEFITS

- 1. FUSION MITRED WELDED SASH AND FRAME**  
Each Procanna sash and frame is precision-mitred, then fusion welded using heat and pressure. This ensures a virtually inseparable bond at every joint.
- 2. MULTICHAMBER POLYRESIN 3<sup>®</sup> PVC**  
Our advanced multi-chamber vinyl frame, manufactured from our exclusive Lead-free, 100% virgin Polyresin 3<sup>®</sup> PVC. Designed to draw moisture away from the glass to the drains, reducing condensation and the formation of mould and mildew.
- 3. FLY MAZE**  
As a standard practice, Procanna windows have a sponge-like insect guard inside the hollow multi-chamber frames. This prevents insects from nesting or entering through a Procanna window frame.
- 4. TRIPLE WEATHER SEALS**  
These seals are oversized for higher performance and built into the frame to prevent any air transfer, allowing for a completely sealed unit.
- 5. PREMIUM HEAVY DUTY HARDWARE**  
Every quality Procanna window utilizes the finest available hardware.
- 6. LOE GLASS OPTION**  
Standard window glass isn't capable of filtering out heat in the summer, or retaining heat in the winter. Procanna LoE coatings boost the insulating value by 40%, reducing the build-up of condensation and protects your interior furnishings from fading in.
- 7. TRIPLE PANE**  
With a 1 3/8" overall glass thickness, the Premium Series offers optimal thermal performance in a complete line up of Casement, Awning, Fixed and Picture windows.
- 8. SIMPLY-CLEAN**  
With our Simply-Clean<sup>®</sup> coating, the sun will actually help to keep your windows clean. As the sun's rays contact the coating, Simply-Clean<sup>®</sup> is activated, helping loosen dust, dirt and other organic deposits.

PRO FEATURES AND BENEFITS

- 1. FUSION MITRED WELDED SASH AND FRAME**  
Each Procanna sash and frame is precision-mitred, then fusion welded using heat and pressure. This ensures a virtually inseparable bond at every joint.
- 2. MULTICHAMBER POLYRESIN 3<sup>®</sup> PVC**  
Our advanced multi-chamber vinyl frame, manufactured from our exclusive Lead-free, 100% virgin Polyresin 3<sup>®</sup> PVC. Designed to draw moisture away from the glass to the drains, reducing condensation and the formation of mould and mildew.
- 3. FLY MAZE**  
As a standard practice, Procanna windows have a sponge-like insect guard inside the hollow multi-chamber frames. This prevents insects from nesting or entering through a Procanna window frame.
- 4. TRIPLE WEATHER SEALS**  
These seals are oversized for higher performance and built into the frame to prevent any air transfer, allowing for a completely sealed unit.
- 5. PREMIUM HEAVY DUTY HARDWARE**  
Every quality Procanna window utilizes the finest available hardware.
- 6. LOE GLASS OPTION**  
Standard window glass isn't capable of filtering out heat in the summer, or retaining heat in the winter. Procanna LoE coatings boost the insulating value by 40%, reducing the build-up of condensation and protects your interior furnishings from fading in.
- 7. GLASS OPTIONS**  
Pro Collection comes standard with double pane but is available in triple with an overall glass thickness of 7/8". Triple pane is available as an option with an overall glass thickness of 7/8".
- 8. SIMPLY-CLEAN**  
With our Simply-Clean<sup>®</sup> coating, the sun will actually help to keep your windows clean. As the sun's rays contact the coating, Simply-Clean<sup>®</sup> is activated, helping loosen dust, dirt and other organic deposits.



# PREMIUM COLLECTION

Our finest windows, the Premium Collection is set apart from the competition by its outstanding quality, superior craftsmanship, innovative design and industry-leading warranty. Flowing architectural Brickmolds offer sculpted curves creating the high-end designer look that knowledgeable homeowners demand and expect from their windows, while standard Low-E & Argon gas filled insulated units ensure superior energy saving performance.

This unique collection highlights our commitment to continuous improvement, and underscores our commitment to providing you the beauty, quality, performance and service you deserve.



CASEMENT



AWNING



PICTURE



FIXED



## STANDARD FEATURES

- 3-1/4" Frame profile
- Triple glazed standard 1-3/8" thickness
- 2-1/2" Argon gas filled chambers
- S Class Super Space
- Full screen overlap
- Energy Star Approved
- NAFS tested and approved, CSA certified

Standard and custom colours available

CASEMENT

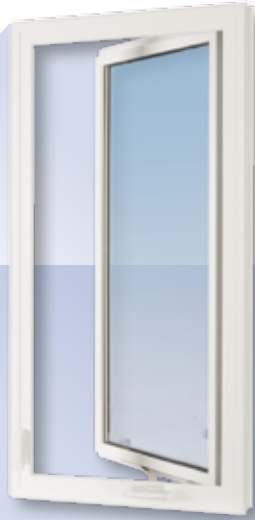

- 3 1/4" Frame Depth
- Interior and exterior options
- Multi-point Locks
- Recessed Folding Handle
- Removable Spring Loaded Screen

AWNING



- Scissor action hardware
- Interior and exterior add on options
- Multi-point Locks
- Recessed Folding Handle
- Removable Spring Loaded Screen
- Sash Opens from Bottom



FIXED



- 3 1/4" Frame Depth
- Box frame construction
- Low profile design
- Combine with any other window

PICTURE



- 3 1/4" frame
- Sash frame construction
- Matching casement design
- Beveled sash frame



At Procanna, it's our attention to detail that makes the difference in the performance of our windows. That same attention to detail can be found in Procanna Shutters, the perfect complement to your new windows or a statement all their own.

Using the same formulation as our windows, Procanna shutters start with the same great vinyl as our windows. Made from 100% virgin vinyl and guarantee a high quality vinyl product every time with a 25 year warranty to ensure your satisfaction.

ARCHITECTURAL SHAPES

SEAMLESS INSTALLATION

RETROFIT OPTIONS

SNAP-ON TRIMS



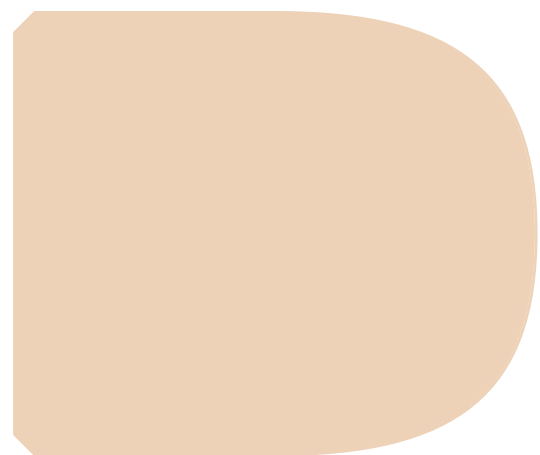

# PROCOLLECTION

**B**uilt to last, our Pro Collection windows are affordably priced without sacrificing the quality you expect from a Procanna window. Offering many of the same features as our top-of-the-line Premium Collection windows including industry-leading Super Spacer<sup>®</sup>, Pro Collection windows are another "best-in-class" product, ideally suited to today's value-conscious consumers.

The Pro Collection sturdy design gives your home and family protection from the elements as well as peace of mind.



CASEMENT

BAY & BOW

SINGLE & DOUBLE HUNG

SINGLE & DOUBLE SLIDER TILTS

SINGLE & DOUBLE LIFT OUT SLIDER

FIXED PICTURE

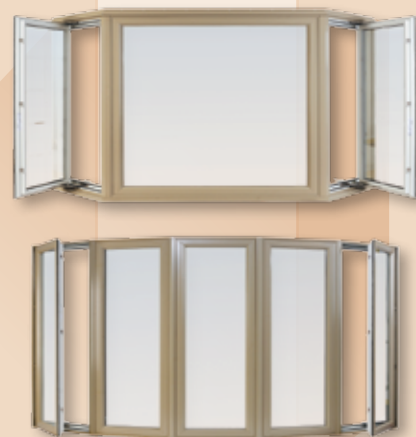

## STANDARD FEATURES

- Exterior Window Coating
- Push Down Screen
- Fusion Welded Sash & Frame
- Energy Star Approved
- CSA with NAFS Certified
- Industry Leading Warranty

CASEMENT



- Multi-point locking hardware
- Full push down screen with overlapping frame
- Heavy-duty handle
- Sash keepers

BAY & BOW



- Variety of interior wood finishes
- Optional insulated head and seat
- Variety of exterior brickmoulds
- Custom made

SINGLE & DOUBLE LIFT OUT SLIDER



- Heavy-duty cam lock and keeper
- Dual interlocking rails between left and right sash
- Push down screen with overlapping frame
- Finger latches
- Drainage flaps
- Night latches

FIXED / PICTURE



- Internal drainage system
- Maximum glass area



SINGLE & DOUBLE HUNG



- Heavy-duty cam lock and keeper
- Constant force balancers
- Dual interlocking rails between top and bottom sash
- Push down screen with overlapping frame
- Mushroom head cast steel shoe

SINGLE & DOUBLE SLIDER



- 1 1/8" Brickmold
- 3/4" Return
- Multi-point Locks
- E-Guard Hardware
- Removable Spring Loaded Screen
- Sash Opens from Side



• Bay and Bow (combination) windows are typically made from a fixed picture window in the middle, with a Casement window on each side.

• Choose window sizes and locations that will allow you to get the greatest amount of natural light. Southern exposures typically bring in more sunlight.



# ENTRANCE COLLECTION

Your home is your castle. It's also your cathedral and your magnificent monument. It's home, sweet home. That's why choosing the right door is one of the most important decisions you, as a homeowner, will make. Because your entrance is your home's first impression, and the welcome your home offers.

Procanna, believes that choosing the ideal door is about more than appearance. It's about choosing a product that will give you and your family security and peace of mind. It's about finding a door that will increase energy efficiency and resale value, while decreasing maintenance costs.



STEEL DOORS

FIBERGLASS DOORS

DECORATIVE DOOR & SIDE LITES

TRANSOMS & SIDE LITES



## STANDARD FEATURES

Energy Star Approved • CSA Approved • Industry Leading Warranty



## STEEL DOORS



Steel doors remain our most popular line due to their solid construction which allows them to resist cracking and years of exposure to the elements, while requiring very little maintenance. They are an ideal choice for homeowners requiring a high degree of security from their entrance doors.

- 4 5/8" Finger Jointed Pine Jamb
- Prefinish White Door Slab
- Thermally Broken Aluminum Sill
- Magnetic & Compression Weatherstrip

## DOOR LITE STYLES



Procanna offers an extensive array of Door Lites, Transom and Side Lites.

For more options visit [Procanna.com](http://Procanna.com)

## TRANSOM & SIDE LITES



### EVERYTHING YOU NEED TO KNOW ABOUT ENTRANCE SYSTEMS

#### GLASS

Achieve the look that's right for you, from basic to lavish, by selecting from our large variety of glass designs.

#### SHAPES

Give a more dramatic look to your entrance by adding shapes like half-round, ellipse, ellipse top, true ellipse or transom windows and sidelites.

#### EXTERIOR TRIMS

Find the perfect look to complement your house with brickmold options like natural wood, vinyl clad or a full range of solid vinyl brickmolds to match your windows. Available in solid white, solid sandalwood or any one of our exterior colours.

#### FRAME

Frame your creation with jambs constructed from strong and durable finger jointed pine. Available in 4 5/8" or 6 5/8" and 7 5/8" depth, natural or vinyl clad, in white, sandalwood or any of our exterior colours.

#### SLAB STYLES

The type and style of the slab chosen, will greatly alter the look of your door. Slabs are available in maintenance free pre-finished white steel; smooth white fiberglass or textured fiberglass in a variety of wood-grain textures.

#### SILLS

Your inswing or outswing entrance system is finished with a thermally broken sill with water deflectors.

## FIBERGLASS

Smooth Fiberglass

Textured Fiberglass



Fiberglass smooth is a primed finish and only compression weatherstrip with fiberglass



### TEXTURED FIBERGLASS DOOR STAIN COLOURS



- 4 5/8" Finger Jointed Pine Jamb
- Fiberglass Textured Slab
- Thermally Broken Aluminum Sill
- Compression Weatherstrip



- Decorative glass not only adds style, but also enhances the appearance of your home and helps create a distinctive and outstanding first impression.



# PATIO DOOR COLLECTION



## PATIO DOOR COLLECTION

### SLIDING PATIO



- All PVC Welded 4 5/8" Multi-Cavity Frame
- Extruded Aluminum Screen
- Multi-point Locking System
- Double Tandem Adjustable Nylon Rollers

### GARDEN/TERRACE



- Prefinish White Door Slabs
- Fixed Structural Center Post
- Removable Sliding Screen
- Magnetic & Compression Weatherstrip

### ALL PVC SWING



**UNPARALLELED WARRANTY**

- LIFETIME ON PVC
- LIFETIME ON HARDWARE
- LIFETIME ON GLASS
- ONE YEAR ON LABOUR

See dealer for full warranty details

- All PVC Multi Chambered Frame
- 4 5/8" Frame Depths
- Multi-point Locking System
- Tempered Glass

### ALL PVC FOLDING



**ALL PVC FOLDING WARRANTY**

- TWENTY YEARS ON PVC COMPONENTS
- TEN YEARS ON HINGE HARDWARE COMPONENTS
- FIVE YEARS ON THE LOCKING HARDWARE COMPONENTS
- TWENTY YEARS ON GLASS
- ONE YEAR ON LABOUR

See dealer for full warranty details

- All PVC Multi Chambered
- Folding Door System
- Solution for Residential or Commercial
- 6 5/8" Frame Depth

### SLIDING PATIO



### GARDEN / TERRANCE



### ALL PVC SWING



### ALL PVC FOLDING



• Folding doors are custom built to your opening, up to 8 panels (max. 39" each).

### STANDARD FEATURES

Energy Star Approved • CSA Approved • Industry Leading Warranty



## MULTI-POINT LOCKING HARDWARE



## HINGES

- Zinc
- Brass
- Black
- Stainless Steel



\*Not all colors are available with these types.

## WEATHERSTRIP

- White
  - Beige
  - Black
- Compression available in all three.  
Magnetic only white.

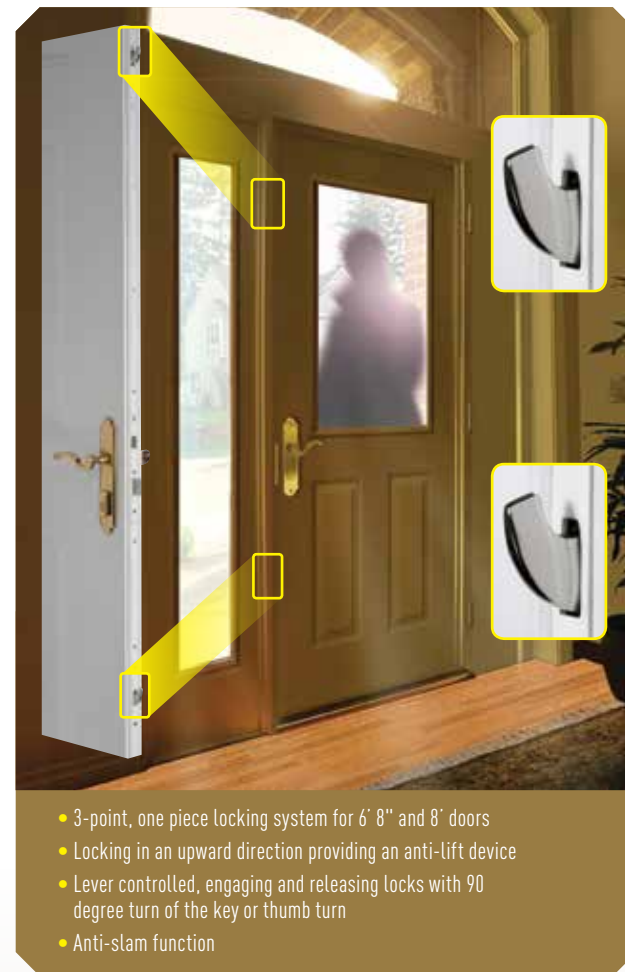

- 3-point, one piece locking system for 6' 8" and 8" doors
- Locking in an upward direction providing an anti-lift device
- Lever controlled, engaging and releasing locks with 90 degree turn of the key or thumb turn
- Anti-slam function

## GRILLS

You can add a personal touch with decorative grills, brickmolds and a splash of colour.



## BRICKMOLDS

Available in an array of sizes. For brick to brick applications or new construction. Made from 100% virgin vinyl - Same material as our windows 100% maintenance free.



## INTERIOR CASING

Our casings are available in PVC and Wood. Oak for staining, Finger Joint for painting and Foam for bending. The PVC casings come with Rosettes to match PVC jamb and complete vinyl finish.

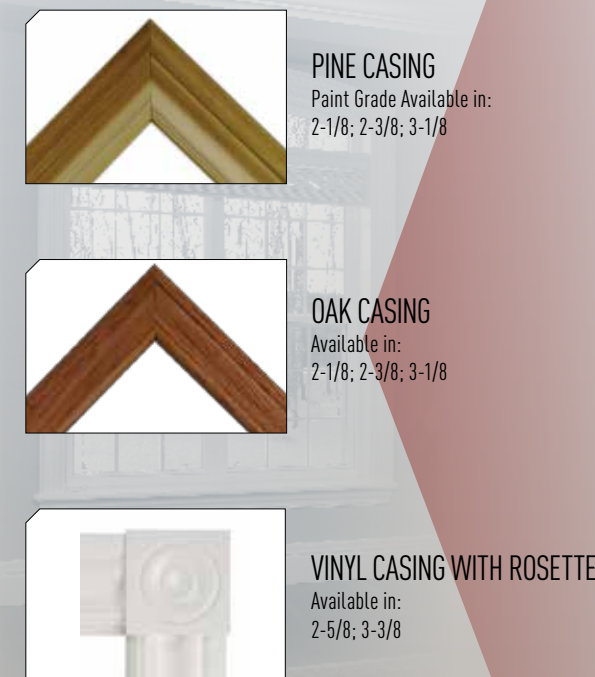

## PAINT COLOURS

Blending exterior window colours with your siding, or creating a bold statement with your entry system can make an enormous to coordinating the exterior of your home and creating an architecturally designed and professionally finished look.



## SILLS

### STANDARD SILL

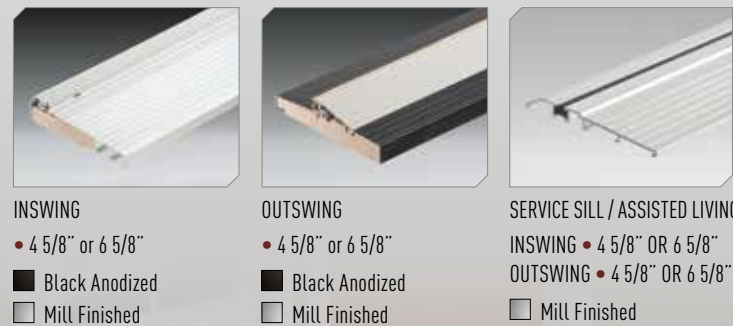

- INSWING**  
• 4 5/8" or 6 5/8"  
■ Black Anodized  
■ Mill Finished  
• Also available in 7 5/8"
- OUTSWING**  
• 4 5/8" or 6 5/8"  
■ Black Anodized  
■ Mill Finished
- SERVICE SILL / ASSISTED LIVING**  
INSWING • 4 5/8" OR 6 5/8"  
OUTSWING • 4 5/8" OR 6 5/8"  
■ Mill Finished

• We now offer PVC smooth and textured jambs for those wanting rot free jambs and stainable like the fiberglass doors.

### HIGH PERFORMANCE SILL

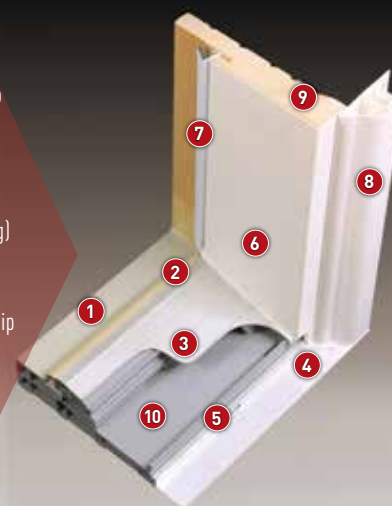

1. PVC Sill
2. Sill Compression Weatherstrip
3. Aluminum Sill Plate
4. Aluminum Sill Extender
5. Drain Hole (with foam bug plug)
6. Vinyl Jamb Cladding (option)
7. Jamb Compression Weatherstrip
8. Exterior Trim (option)
9. Wood Jamb
10. PVC Sill (internal view)

Procanna Windows offers a few sill types to complement the need of your entrance system. Our standard mill finish sill is the most popular on steel and fiberglass smooth entrance systems. The high performance sill is our all PVC - No rot sill, no sweep required alternative, also rated with a B2.

# PRODUCT PERFORMANCE RATINGS

## ENERGY STAR® CERTIFIED PROTECTION

Coast to coast, Procanna® Windows with LoE glass with LoE glass coatings and Argon gas are ENERGY STAR® qualified.

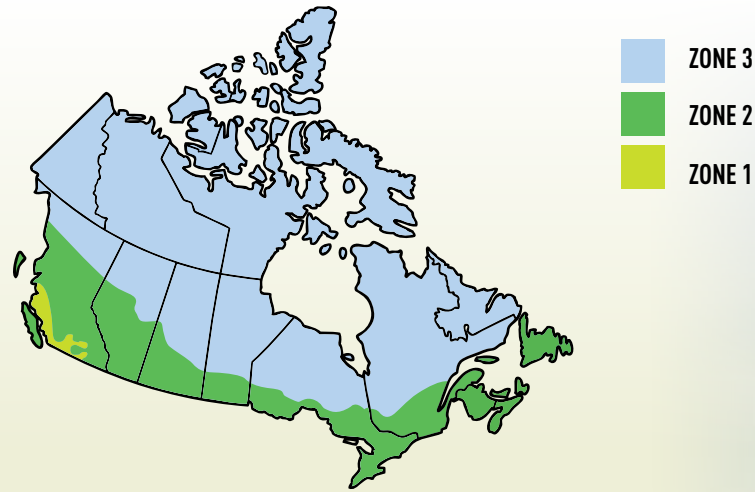

Zone 1 - 3	U Factor	ER Rating
1	1.60 (0.28)	25
2	1.40 (0.25)	29
3	1.20 (0.21)	34

New Rating System as of Feb. 1/15

## PREMIUM COLLECTION

AWNING	PERFORMANCE RATINGS				
	Energy Star® Zones	Energy Rating	Air	Water	Wind
Type					
Using LoE / Argon glass	3	34	A3	B7	C5

Min A1 B1 C1 / Max A3 B7 C5

CASEMENT	PERFORMANCE RATINGS				
	Energy Star® Zones	Energy Rating	Air	Water	Wind
Type					
Using LoE / Argon glass	3	34	A3	B7	C5

Min A1 B1 C1 / Max A3 B7 C5

FIXED	PERFORMANCE RATINGS				
	Energy Star® Zones	Energy Rating	Air	Water	Wind
Type					
Using LoE / Argon glass	3	41	Fixed	B7	C5

Min A1 B1 C1 / Max A3 B7 C5

PICTURE	PERFORMANCE RATINGS				
	Energy Star® Zones	Energy Rating	Air	Water	Wind
Type					
Using LoE / Argon glass	3	44	Fixed	B7	C5

Min A1 B1 C1 / Max A3 B7 C5

## ENTRANCE COLLECTION

SLIDING PATIO	PERFORMANCE RATINGS				
	Energy Star® Zones	Energy Rating	Air	Water	Wind
Type					
Standard	1/2	31	A3	B3	C3

Min A1 B1 C1 / Max A3 B7 C5

## PRO COLLECTION

AWNING	PERFORMANCE RATINGS				
	Energy Star® Zones	Energy Rating	Air	Water	Wind
Type					
Using LoE/Argon glass	2	34	A3	B7	C5

Min A1 B1 C1 / Max A3 B7 C5

CASEMENT	PERFORMANCE RATINGS				
	Energy Star® Zones	Energy Rating	Air	Water	Wind
Type					
Using LoE / Argon glass	2	29	A3	B7	C5

Min A1 B1 C1 / Max A3 B7 C5

SINGLE & DOUBLE HUNG	PERFORMANCE RATINGS				
	Energy Star® Zones	Energy Rating	Air	Water	Wind
Type					
Using LoE / Argon glass	2	30	A3	B7	C3

Min A1 B1 C1 / Max A3 B7 C5

SINGLE & DOUBLE SLIDER	PERFORMANCE RATINGS				
	Energy Star® Zones	Energy Rating	Air	Water	Wind
Type					
Using LoE / Argon glass	2	30	A2	B2	C3

Min A1 B1 C1 / Max A3 B7 C5

SINGLE & DOUBLE LIFT OUT SLIDER	PERFORMANCE RATINGS				
	Energy Star® Zones	Energy Rating	Air	Water	Wind
Type					
Using LoE / Argon glass	2	30	A2	B2	C3

Min A1 B1 C1 / Max A3 B7 C5

FIXED	PERFORMANCE RATINGS				
	Energy Star® Zones	Energy Rating	Air	Water	Wind
Type					
Using LoE / Argon glass	3	34	A2	B2	C3

Min A1 B1 C1 / Max A3 B7 C5

# PROCANNA WARRANTIES

Procanna windows, patio doors and entrance systems are covered by a warranty that is unparalleled in the industry. You can expect the highest quality standards and the beauty you deserve on any window, patio door or entrance system.

## PROCANNA WINDOWS COLLECTION

### WARRANTY

#### UNPARALLELED WARRANTY

#### LIFETIME WARRANTY ON WHITE VINYL FRAME AND VINYL SASH MEMBERS

Procanna Windows are warranted against such defects in material that might result in blistering, peeling, flaking, corroding and fading of the frame or sash members for the lifetime of the product from the date of installation.

#### LIFETIME WARRANTY ON SUPER SPACER® INSULATING GLASS

Premium Collection Window warrants that the insulating glass units Super Spacer® contained in the windows fabricated from select A-quality glass, and that under normal conditions there will not be an obvious obstruction of vision, which is the result of film formation or dust collection between the interior glass surfaces, for the life of the window in accordance with all terms specified in this warranty.

#### LIFETIME WARRANTY HARDWARE

Premium Collection Window warrants that the hardware shall remain in good operational condition for the lifetime of the product excluding abuse of hardware such as over tightening of mechanism which may cause the roto gear to strip commencing from the date of installation.

#### INTERIOR WARRANTY LAMINATE FINISH

Premium Collection Window warrants that the vinyl/pvc laminate will not delaminate, chip, crack or blister during the life of the product.

#### SOLAR BOND™ PAINT

Solar Bond™ standard colours are warranted against such defects in material and workmanship that might result from paint peeling, flaking, cracking and major discoloration for a period of fifteen (15) years that is not caused by

For full warranty details please see the dealer nearest you or [PROCANNA.com](http://PROCANNA.com)

## ENTRANCE COLLECTION

### WARRANTY

#### UNPARALLELED WARRANTY

Procanna Door Collection are warranted against defects for a period of **TEN YEARS**.

#### COMPONENTS

Procanna Doors have a components warranty against manufacturing defects including hardware, hinges, jambs, sills and slabs against rusting or delaminating for a period of **TEN YEARS**.

#### DOORLITES

Procanna Doors are warranted for doorlites against defects in workmanship, components and seal failure resulting in a film of moisture between the glass for a period of **TEN YEARS**.

#### ENHANCEMENTS

Any door combined with our pre-finished slabs comes complete with our standard **TEN YEAR** comprehensive warranty plus a **TWENTY YEAR** warranty on the pre-finished white slab against peeling, blistering, chalking and discolouring. All fiberglass slabs come with a **LIFETIME** warranty against manufacturing defects.  
*(Fiberglass must be painted or stained within 45 days to maintain this warranty).*

For full warranty details please see the dealer nearest you or [PROCANNA.com](http://PROCANNA.com)



Procanna Windows and Doors are distributed exclusively across Canada by



One company. Hundreds of products. **Endless possibilities.**



Take the guesswork out of your exterior makeover. Try different products and colour combinations. You can use our stock photos, or upload and customize a photo of your own home.

Visit the enVision it section of [www.procanna.com](http://www.procanna.com)

**Mitten** has earned a solid reputation across Canada for its customer driven approach to service and unwavering dedication to Exterior Building Products Distribution.

**Mitten Locations:**

**Ontario Window and Door Hotline: Ph: 855.505.4717 • Fax: 866.375.6922**

**Ontario branches**

**Ottawa: 800.267.1550 • Scarborough: 866.526.3549**

**Brantford: 800.265.2550 • London: 877.858.2675**

**Western Canada Window and Door Hotline: 844.560.1526 • Fax: 866.397.4870**

**Westen branches:**

**Langley: 888.566.8866 • Calgary: 888.253.1944 • Edmonton: 800.853.9472**

**Regina: 877.643.4785 • Saskatoon: 877.373.5777 • Winnipeg: 866.264.8023**



Visit us online at: [PROCANNA.COM](http://PROCANNA.COM)



49-803-110-05